



Through sockets 1/2" in mm

SHS-29

SHS-...

SAM Outillage

10 rue Camille de Rochetaillée
42000 Saint-Etienne - France

RCS Saint-Etienne B 338 002 231 | SAS au capital de 8 189 583 €

<https://www.sam-outillage.com/>

Photos and texts not contractually binding. Do not litter. Document generated on 2024-05-02 03:08:25





DESCRIPTION

Through sockets 1/2" in mm

Forged chrome-vanadium steel.

Socket clipped in place.

Bright polished chrome-plate finish.

Used to access nuts on threaded rods.

Used with through ratchets S-155B or S-156B.

Sockets 10 to 19 mm: ratchet S-155B and extension S-201.

Sockets 21 to 32 mm: ratchet S-156B and extension S-202.

SAM Surface Drive profile to preserve the nuts.

STANDARDS / DIRECTIVES

NF ISO 1174-1

SAM Outillage

10 rue Camille de Rochetaillée
42000 Saint-Etienne - France

RCS Saint-Etienne B 338 002 231 | SAS au capital de 8 189 583 €

<https://www.sam-outillage.com/>

Photos and texts not contractually binding. Do not litter. Document generated on 2024-05-02 03:08:25



SPECIFIC DATA

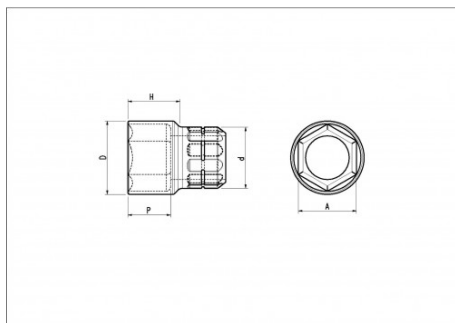

Designation	TROUGHGOING SOCKET 1/2" 6P SD29MM
Sales reference	SHS-29
Weight (g)	89
H (mm)	23.72
d (mm)	29
D (mm)	37.86
P (mm)	13.14
A (mm)	29
Guarantee	O

Guarantee applied

O | SAM TOOL guarantee.

Guarantee without time limit on the tools used under normal conditions.

[>> Find out more](#)

SAM Outillage

10 rue Camille de Rochetaillée
42000 Saint-Etienne - France

RCS Saint-Etienne B 338 002 231 | SAS au capital de 8 189 583 €

<https://www.sam-outillage.com/>

