



Through sockets 1/4" in mm

RHS-6

RHS-...

SAM Outillage

10 rue Camille de Rochetaillée
42000 Saint-Etienne - France

RCS Saint-Etienne B 338 002 231 | SAS au capital de 8 189 583 €

<https://www.sam-outillage.com/>

Photos and texts not contractually binding. Do not litter. Document generated on 2024-04-24 07:42:18





DESCRIPTION

Through sockets 1/4" in mm

Forged chrome-vanadium steel.Socket held in place with a clip.Bright polished chrome-plate finish.Allows you to access nuts on threaded nuts.For use with ratchet R-152B and extension R-201.This wall for better access to nuts.Surface drive profile to preserve the nuts.

STANDARDS / DIRECTIVES

NF ISO 691, NF ISO 1711-1

SAM Outillage

10 rue Camille de Rochetaillée
42000 Saint-Etienne - France

RCS Saint-Etienne B 338 002 231 | SAS au capital de 8 189 583 €

<https://www.sam-outillage.com/>

Photos and texts not contractually binding. Do not litter. Document generated on 2024-04-24 07:42:18



SPECIFIC DATA

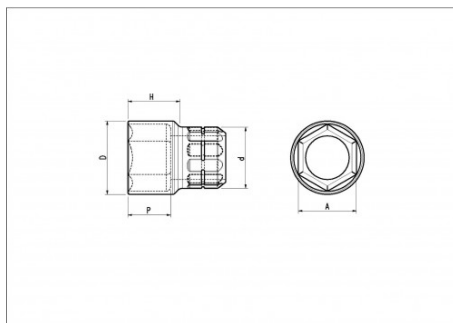

Designation	TROUGHGOING SOCKET 1/4" 6 POINTS SD 6MM
Sales reference	RHS-6
Weight (g)	12
H (mm)	15.55
d (mm)	12.4
D (mm)	9.68
P (mm)	5.70
A (mm)	6
Guarantee	O

Guarantee applied

O | SAM TOOL guarantee.

Guarantee without time limit on the tools used under normal conditions.

[>> Find out more](#)

SAM Outillage

10 rue Camille de Rochetaillée
42000 Saint-Etienne - France

RCS Saint-Etienne B 338 002 231 | SAS au capital de 8 189 583 €

<https://www.sam-outillage.com/>

