



2-arm extractors for minor mechanical jobs

EX-903N

EX-90...N

SAM Outillage

10 rue Camille de Rochetaillée
42000 Saint-Etienne - France

RCS Saint-Etienne B 338 002 231 | SAS au capital de 8 189 583 €

<https://www.sam-outillage.com/>

Photos and texts not contractually binding. Do not litter. Document generated on 2024-05-03 08:49:19





DESCRIPTION

2-arm extractors for minor mechanical jobs

Pullers for small mechanical applications.

Exterior gripping only.

Very convenient to use thanks to the self-tightening device, the multiple-position setting and the slenderness of the claws.

Variable capacity depending on the positioning of the claws: crossed or uncrossed.

Optimum accessibility / power ratio.

Arc-shaped claws.

SPECIFIC DATA

SAM Outillage

10 rue Camille de Rochetaillée
42000 Saint-Etienne - France

RCS Saint-Etienne B 338 002 231 | SAS au capital de 8 189 583 €

<https://www.sam-outillage.com/>

Photos and texts not contractually binding. Do not litter. Document generated on 2024-05-03 08:49:19



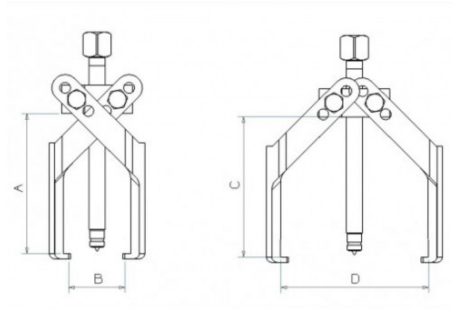

Designation	2-ARM EXTRACTOR FOR MINOR MECHANICAL JOBS
Sales reference	EX-903N
Weight (kg)	0.83
C (mm)	120
b (mm)	-
D (mm)	125
A (mm)	125
B (mm)	70
a (mm)	-
Guarantee	2

Guarantee applied

O | SAM TOOL guarantee.

Guarantee without time limit on the tools used under normal conditions.

[>> Find out more](#)

SAM Outillage

10 rue Camille de Rochetaillée
42000 Saint-Etienne - France

RCS Saint-Etienne B 338 002 231 | SAS au capital de 8 189 583 €

<https://www.sam-outillage.com/>

Photos and texts not contractually binding. Do not litter. Document generated on 2024-05-03 08:49:19

