



2-rigid arm inner-outer extractors

EX-830

EX-83...

SAM Outillage

10 rue Camille de Rochetaillée
42000 Saint-Etienne - France

RCS Saint-Etienne B 338 002 231 | SAS au capital de 8 189 583 €

<https://www.sam-outillage.com/>

Photos and texts not contractually binding. Do not litter. Document generated on 2024-05-02 11:02:36





DESCRIPTION

2-rigid arm inner-outer extractors

PRACTICAL: Reversible claws.SAFETY: Lockable claws.

Reliable, powerful pullers for the dependable, fast extraction of bearings, pulleys and wheels thanks to the fine claws suited to a multitude of needs. Very quick to adjust thanks to a single nut on the flange.Interior and exterior gripping thanks to the reversible claws.Shouldering of the arms on the bracket guaranteeing greater strength. Lockable claws.

SPECIFIC DATA

SAM Outillage

10 rue Camille de Rochetaillée
42000 Saint-Etienne - France

RCS Saint-Etienne B 338 002 231 | SAS au capital de 8 189 583 €

<https://www.sam-outillage.com/>

Photos and texts not contractually binding. Do not litter. Document generated on 2024-05-02 11:02:36



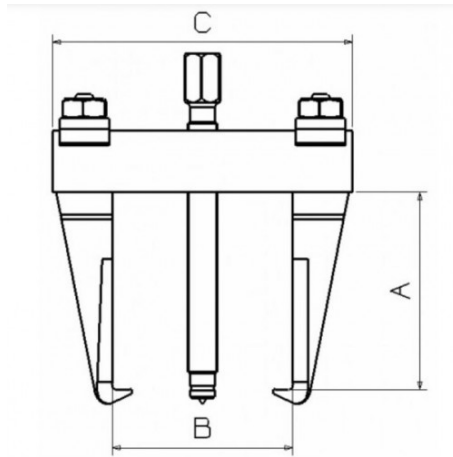

Designation	2-RIGID ARM EXTRACTOR - INNER OUTER
Sales reference	EX-830
Weight (kg)	0.28
C (mm)	72
A (mm)	50
Power T	1
B mm	60
B mm	12
B mm	80
B mm	55
Guarantee	O

Guarantee applied

O | SAM TOOL guarantee.

Guarantee without time limit on the tools used under normal conditions.

[>> Find out more](#)

SAM Outillage

10 rue Camille de Rochetaillée
42000 Saint-Etienne - France

RCS Saint-Etienne B 338 002 231 | SAS au capital de 8 189 583 €

<https://www.sam-outillage.com/>

Photos and texts not contractually binding. Do not litter. Document generated on 2024-05-02 11:02:36

