



2-arm extractor with adjustable interior-exterior width

EX-825N
EX-82...N

SAM Outillage

10 rue Camille de Rochetaillée
42000 Saint-Etienne - France

RCS Saint-Etienne B 338 002 231 | SAS au capital de 8 189 583 €

<https://www.sam-outillage.com/>

Photos and texts not contractually binding. Do not litter. Document generated on 2024-04-30 23:00:03





DESCRIPTION

2-arm extractor with adjustable interior-exterior width

Two-arm, adjustable-width pullers. Interior and exterior gripping thanks to reversible claws. Blocking of the claws with screws and nuts. End of the pressure screw with rotary quenched tip to secure central contact without damaging the ends of the shaft. Simple, quick adjustment of the separation. Fine claws suited to a multitude of needs.

SPECIFIC DATA

SAM Outillage

10 rue Camille de Rochetaillée
42000 Saint-Etienne - France

RCS Saint-Etienne B 338 002 231 | SAS au capital de 8 189 583 €

<https://www.sam-outillage.com/>

Photos and texts not contractually binding. Do not litter. Document generated on 2024-04-30 23:00:03



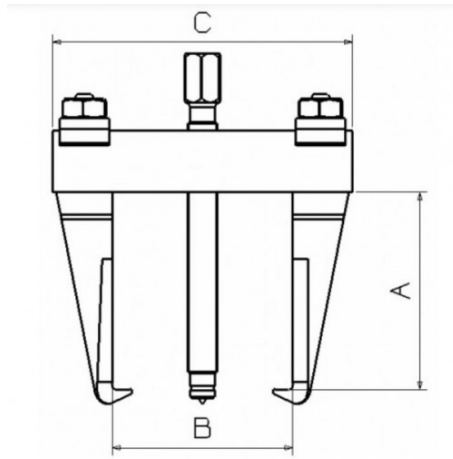

Designation	2-ARM AND ADJUSTABLE-WIDTH EXTRACTOR
Sales reference	EX-825N
Weight (kg)	7.7
C (mm)	325
A (mm)	205
Power T	12
B mm	240
B mm	50
B mm	325
B mm	175
Guarantee	O

Guarantee applied

O | SAM TOOL guarantee.

Guarantee without time limit on the tools used under normal conditions.

[>> Find out more](#)

SAM Outillage

10 rue Camille de Rochetaillée
42000 Saint-Etienne - France

RCS Saint-Etienne B 338 002 231 | SAS au capital de 8 189 583 €

<https://www.sam-outillage.com/>

Photos and texts not contractually binding. Do not litter. Document generated on 2024-04-30 23:00:03

