



Short 2-arm self-tightening extractors

EX-623

EX-62...

SAM Outillage

10 rue Camille de Rochetaillée
42000 Saint-Etienne - France

RCS Saint-Etienne B 338 002 231 | SAS au capital de 8 189 583 €

<https://www.sam-outillage.com/>

Photos and texts not contractually binding. Do not litter. Document generated on 2024-05-03 16:54:28





DESCRIPTION

Short 2-arm self-tightening extractors

MULTI-PURPOSE: 3 setting positions. SAFETY: self-tightening arms.

Short self-tightening 2-claw pullers (3 heights). Pullers with self-tightening claws particularly well-suited to extracting pulleys, wheels and ball-bearings. Versatile thanks to the adjustable and variable extraction depths. Particularly well-suited for the extraction of grooved pulleys for V-belts, engine flywheels mounted on long shafts.

SPECIFIC DATA

SAM Outillage

10 rue Camille de Rochetaillée
42000 Saint-Etienne - France

RCS Saint-Etienne B 338 002 231 | SAS au capital de 8 189 583 €

<https://www.sam-outillage.com/>

Photos and texts not contractually binding. Do not litter. Document generated on 2024-05-03 16:54:28



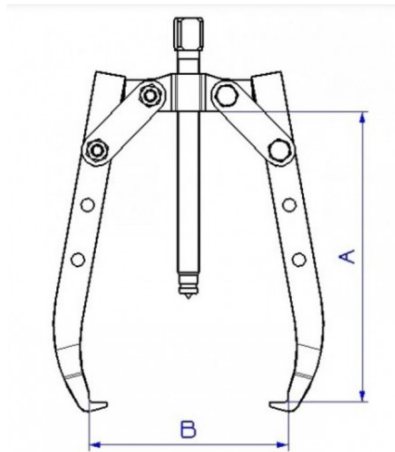

Designation	SHORT 2-ARM SELF-TIGHTENING EXTRACTOR
Sales reference	EX-623
Weight (kg)	1.350
A (mm)	185
screw	EX-623-V1
B (mm)	175
screw	EX-623-C1
Guarantee	4T

Guarantee applied

O | SAM TOOL guarantee.

Guarantee without time limit on the tools used under normal conditions.

[>> Find out more](#)

SAM Outillage

10 rue Camille de Rochetaillée
42000 Saint-Etienne - France

RCS Saint-Etienne B 338 002 231 | SAS au capital de 8 189 583 €

<https://www.sam-outillage.com/>

Photos and texts not contractually binding. Do not litter. Document generated on 2024-05-03 16:54:28

