



Long 2-arm self-tightening extractors

EX-623-L

EX-62...-L

SAM Outillage

10 rue Camille de Rochetaillée
42000 Saint-Etienne - France

RCS Saint-Etienne B 338 002 231 | SAS au capital de 8 189 583 €

<https://www.sam-outillage.com/>

Photos and texts not contractually binding. Do not litter. Document generated on 2024-05-02 01:45:47





DESCRIPTION

Long 2-arm self-tightening extractors

MULTI-PURPOSE: 4 setting positions.SAFETY: long self-tightening arms.

Long self-tightening 2-arm puller (4 heights).Pullers with self-tightening claws particularly well-suited to extracting pulleys, wheels and ball-bearings.Versatile thanks to the adjustable and variable extraction depths.Particularly well-suited for the extraction of grooved pulleys for V-belts, engine flywheels mounted on long shafts. Smooth nickel finish.

SPECIFIC DATA

SAM Outillage

10 rue Camille de Rochetaillée
42000 Saint-Etienne - France

RCS Saint-Etienne B 338 002 231 | SAS au capital de 8 189 583 €

<https://www.sam-outillage.com/>

Photos and texts not contractually binding. Do not litter. Document generated on 2024-05-02 01:45:47



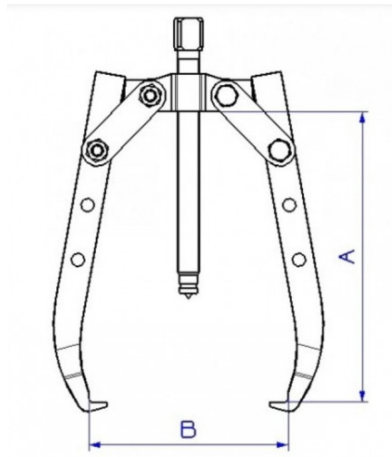

Designation	LONG 2-ARM SELF-TIGHTENING EXTRACTOR
Sales reference	EX-623-L
Weight (kg)	1.36
A (mm)	210
screw	EX-623-L-V1
B (mm)	220
screw	EX-623-L-C1
Guarantee	4T

Guarantee applied

O | SAM TOOL guarantee.

Guarantee without time limit on the tools used under normal conditions.

[>> Find out more](#)

SAM Outillage

10 rue Camille de Rochetaillée
42000 Saint-Etienne - France

RCS Saint-Etienne B 338 002 231 | SAS au capital de 8 189 583 €

<https://www.sam-outillage.com/>

Photos and texts not contractually binding. Do not litter. Document generated on 2024-05-02 01:45:47

