



2-claw extractors with fine branches

EX-320-3

EX-320...

SAM Outillage

10 rue Camille de Rochetaillée
42000 Saint-Etienne - France

RCS Saint-Etienne B 338 002 231 | SAS au capital de 8 189 583 €

<https://www.sam-outillage.com/>

Photos and texts not contractually binding. Do not litter. Document generated on 2024-04-30 10:09:40





DESCRIPTION

2-claw extractors with fine branches

PRACTICAL: Thin legs for accessing restricted spaces. **COMFORT:** Adjustable extraction width.

Int / Ext pullers with very fine arms for very confined spaces. Provides access to places where other pullers can't go. They are ideally suited to very confined spaces and for limited extraction power levels, without requiring a great amount of force. Ideal for extracting bearings, pulleys and gears.

SPECIFIC DATA

SAM Outillage

10 rue Camille de Rochetaillée
42000 Saint-Etienne - France

RCS Saint-Etienne B 338 002 231 | SAS au capital de 8 189 583 €

<https://www.sam-outillage.com/>

Photos and texts not contractually binding. Do not litter. Document generated on 2024-04-30 10:09:40



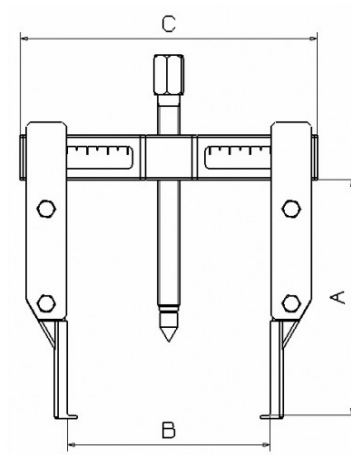

Designation	FINE-LEG 2-CLAW EXTRACTOR
Sales reference	EX-320-3
Weight (kg)	2.145
C (mm)	186
A (mm)	195
Power T	5
B mm	140
B mm	35
B mm	185
B mm	98
Guarantee	O

Guarantee applied

O | SAM TOOL guarantee.

Guarantee without time limit on the tools used under normal conditions.

[>> Find out more](#)

SAM Outillage

10 rue Camille de Rochetaillée
42000 Saint-Etienne - France

RCS Saint-Etienne B 338 002 231 | SAS au capital de 8 189 583 €

<https://www.sam-outillage.com/>

Photos and texts not contractually binding. Do not litter. Document generated on 2024-04-30 10:09:40

