



## Extraction counter-support

**EX-111-TN**

EX-11...TN

### SAM Outillage

10 rue Camille de Rochetaillée  
42000 Saint-Etienne - France

RCS Saint-Etienne B 338 002 231 | SAS au capital de 8 189 583 €

<https://www.sam-outillage.com/>

Photos and texts not contractually binding. Do not litter. Document generated on 2024-04-30 19:20:58





## DESCRIPTION

### Extraction counter-support

Designed to be coupled with separators EX-11..ANSmooth nickel finish.Adjustable width making it possible to cope with a multitude of situations.

## SPECIFIC DATA

### SAM Outillage

10 rue Camille de Rochetaillée  
42000 Saint-Etienne - France

RCS Saint-Etienne B 338 002 231 | SAS au capital de 8 189 583 €

<https://www.sam-outillage.com/>

Photos and texts not contractually binding. Do not litter. Document generated on 2024-04-30 19:20:58



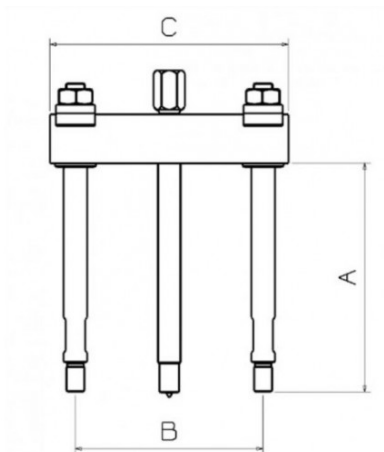

Designation	EXTRACTION COUNTER-SUPPORT
Sales reference	EX-111-TN
Weight (kg)	2.82
C (mm)	210
A (mm)	175
Power T	10
B mm	195
B mm	62
Guarantee	O

**Guarantee applied**

**O | SAM TOOL guarantee.**

Guarantee without time limit on the tools used under normal conditions.

[>> Find out more](#)

**SAM Outillage**

10 rue Camille de Rochetaillée  
42000 Saint-Etienne - France

RCS Saint-Etienne B 338 002 231 | SAS au capital de 8 189 583 €

<https://www.sam-outillage.com/>

Photos and texts not contractually binding. Do not litter. Document generated on 2024-04-30 19:20:58

