



Separator extractors

EX-111-AN

EX-11...AN

SAM Outillage

10 rue Camille de Rochetaillée
42000 Saint-Etienne - France

RCS Saint-Etienne B 338 002 231 | SAS au capital de 8 189 583 €

<https://www.sam-outillage.com/>

Photos and texts not contractually binding. Do not litter. Document generated on 2024-05-03 05:31:26





DESCRIPTION

Separator extractors

Separators particularly well suited for extracting ball bearings or bearing races backed on to a part making it impossible to grip it with a puller. The SAM separators are used with the extraction counter-support EX-11..TN.

SPECIFIC DATA

SAM Outillage

10 rue Camille de Rochetaillée
42000 Saint-Etienne - France

RCS Saint-Etienne B 338 002 231 | SAS au capital de 8 189 583 €

<https://www.sam-outillage.com/>

Photos and texts not contractually binding. Do not litter. Document generated on 2024-05-03 05:31:26



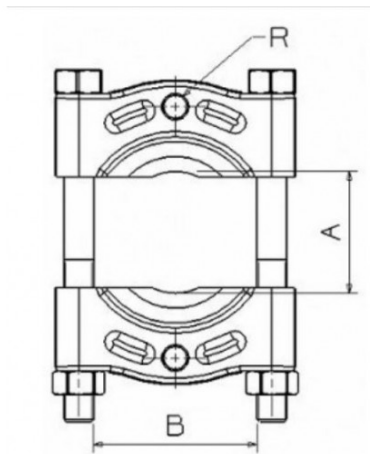

Designation	SEPARATOR EXTRACTOR
Sales reference	EX-111-AN
Weight (kg)	2.5
e (mm)	2.5
A maxi mm	110
B (mm)	110
A min (mm)	10
R (mm)	5/8"
Guarantee	O

Guarantee applied

O | SAM TOOL guarantee.

Guarantee without time limit on the tools used under normal conditions.

[>> Find out more](#)

SAM Outillage

10 rue Camille de Rochetaillée
42000 Saint-Etienne - France

RCS Saint-Etienne B 338 002 231 | SAS au capital de 8 189 583 €

<https://www.sam-outillage.com/>

Photos and texts not contractually binding. Do not litter. Document generated on 2024-05-03 05:31:26

