



Extraction counter-support

EX-110-T1N

EX-11...TN

SAM Outillage

10 rue Camille de Rochetaillée
42000 Saint-Etienne - France

RCS Saint-Etienne B 338 002 231 | SAS au capital de 8 189 583 €

<https://www.sam-outillage.com/>

Photos and texts not contractually binding. Do not litter. Document generated on 2024-04-30 21:28:14





DESCRIPTION

Extraction counter-support

Designed to be coupled with separators EX-11..ANSmooth nickel finish.Adjustable width making it possible to cope with a multitude of situations.

SPECIFIC DATA

SAM Outillage

10 rue Camille de Rochetaillée
42000 Saint-Etienne - France

RCS Saint-Etienne B 338 002 231 | SAS au capital de 8 189 583 €

<https://www.sam-outillage.com/>

Photos and texts not contractually binding. Do not litter. Document generated on 2024-04-30 21:28:14



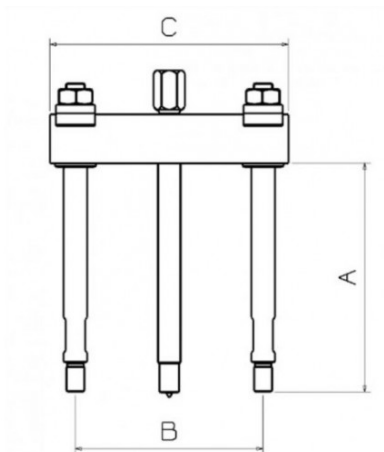

Designation	EXTRACTION COUNTER-SUPPORT
Sales reference	EX-110-T1N
Weight (kg)	1.03
C (mm)	156
A (mm)	115
Power T	2
B mm	140
B mm	46
Guarantee	O

Guarantee applied

O | SAM TOOL guarantee.

Guarantee without time limit on the tools used under normal conditions.

[>> Find out more](#)

SAM Outillage

10 rue Camille de Rochetaillée
42000 Saint-Etienne - France

RCS Saint-Etienne B 338 002 231 | SAS au capital de 8 189 583 €

<https://www.sam-outillage.com/>

Photos and texts not contractually binding. Do not litter. Document generated on 2024-04-30 21:28:14

