

Plumber's wrenches in mm

DP-23

DP-...

SAM Outillage

10 rue Camille de Rochetaillée
42000 Saint-Etienne - France

RCS Saint-Etienne B 338 002 231 | SAS au capital de 8 189 583 €

<https://www.sam-outillage.com/>

Photos and texts not contractually binding. Do not litter. Document generated on 2024-05-02 00:58:43



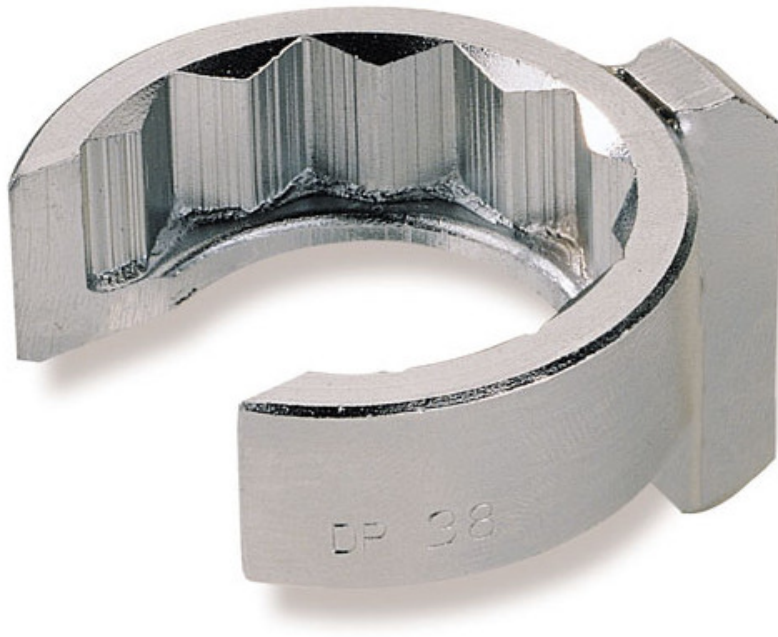

DESCRIPTION

Plumber's wrenches in mm

Socket 12 splines with male square of 3/8.

Tailcoat revetment of the screw.

Use with joint or extensions.

Slotted head to allow to way of the tip.

Conceived for a minimal obstruction.

Presentation: antioxidant chromed.

STANDARDS / DIRECTIVES

NF ISO 1174-1

SAM Outillage

10 rue Camille de Rochetaillée
42000 Saint-Etienne - France

RCS Saint-Etienne B 338 002 231 | SAS au capital de 8 189 583 €

<https://www.sam-outillage.com/>

Photos and texts not contractually binding. Do not litter. Document generated on 2024-05-02 00:58:43



SPECIFIC DATA

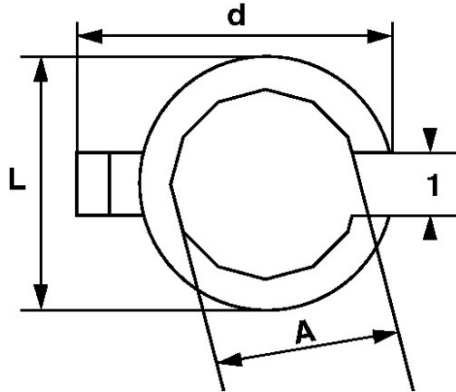

Designation	6-FLAT PLUMBER'S SOCKET 23 MM
Sales reference	DP-23
L (mm)	31
Weight (g)	52
l (mm)	19
d (mm)	37
A (mm)	23
Guarantee	O

Guarantee applied

O | SAM TOOL guarantee.

Guarantee without time limit on the tools used under normal conditions.

[>> Find out more](#)

SAM Outillage

10 rue Camille de Rochetaillée
42000 Saint-Etienne - France

RCS Saint-Etienne B 338 002 231 | SAS au capital de 8 189 583 €

<https://www.sam-outillage.com/>

Photos and texts not contractually binding. Do not litter. Document generated on 2024-05-02 00:58:43

