



## Adjusting vice

**397-10N**

397-...

### SAM Outillage

10 rue Camille de Rochetaillée  
42000 Saint-Etienne - France

RCS Saint-Etienne B 338 002 231 | SAS au capital de 8 189 583 €

<https://www.sam-outillage.com/>

Photos and texts not contractually binding. Do not litter. Document generated on 2024-05-08 19:41:19





## DESCRIPTION

### Adjusting vice

replaceable jaws

forged steel, induction hardening and rectified

monobloc jaws, working plane with anvil

lacquered presentation

## SPECIFIC DATA

### SAM Outillage

10 rue Camille de Rochetaillée  
42000 Saint-Etienne - France

RCS Saint-Etienne B 338 002 231 | SAS au capital de 8 189 583 €

<https://www.sam-outillage.com/>

Photos and texts not contractually binding. Do not litter. Document generated on 2024-05-08 19:41:19



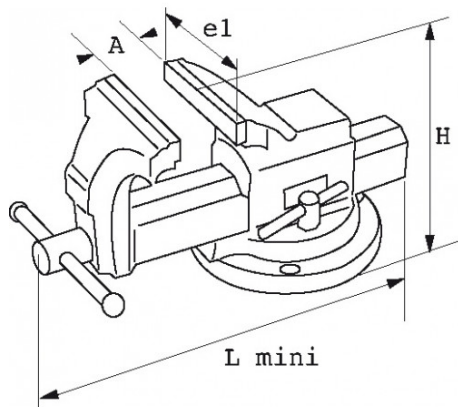

Designation	ADJUSTING VICE 130 MM
Sales reference	397-10N
L (mm)	310
Weight (kg)	7.000
H (mm)	130
e1 (mm)	100
A maxi mm	130
Guarantee	O

**Guarantee applied**

**O | SAM TOOL guarantee.**

Guarantee without time limit on the tools used under normal conditions.

[>> Find out more](#)

**SAM Outillage**

10 rue Camille de Rochetaillée  
42000 Saint-Etienne - France

RCS Saint-Etienne B 338 002 231 | SAS au capital de 8 189 583 €

<https://www.sam-outillage.com/>

Photos and texts not contractually binding. Do not litter. Document generated on 2024-05-08 19:41:19

